

Article number: 0101125
 Description: Retaining ring A 155 DIN 471
 Spring steel
 Note: Fitted with ZGA pilers

Measures

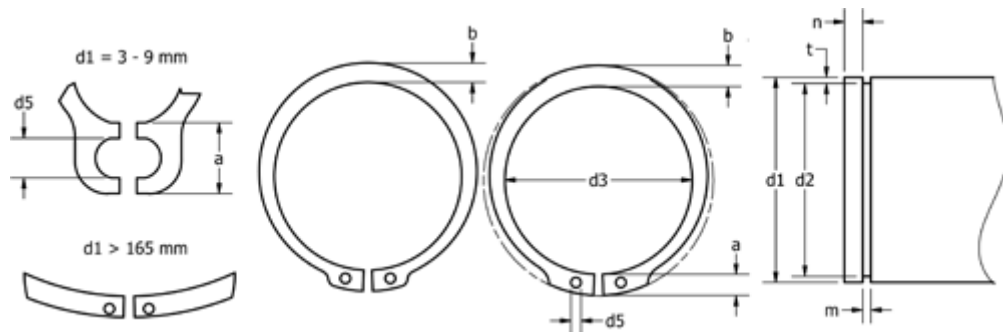

a max	= 13.0	FN kN	= 199.0	s	= 4.00
AN mm ²	= 1198.0	FRg kN	= 52.60	t	= 2.50
b	= 12.0	FR kN	= 352.00	tol	= -0.63
d1	= 155	g	= 4.0	tol	= -0.10
d2	= 150.0	K kN-mm	= 814.00	tol	= +0,63-1,50
d3	= 146.0	m min	= 4.15	Tong	= ZGA-5
d5 min	= 4.0	n abl x 1000	= 3.0	Weight kg/1000	= 135.000
Description	= A155	Nominal drive	= 7.5		